

A	B	C1	C2	C3	D
1	S507-1007	1254	200	16	1/1
2	S507-3008	168	200	16	1/1
3	S507-3009	168	183	16	1/1
4	S507-3010	168	183	16	1/1
5	S507-4501	1221	168	16	1/1

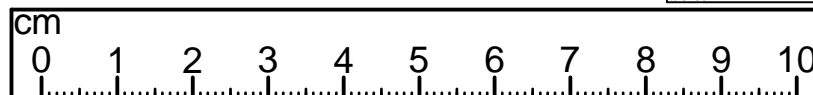

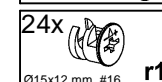
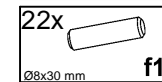
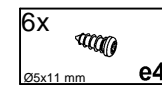
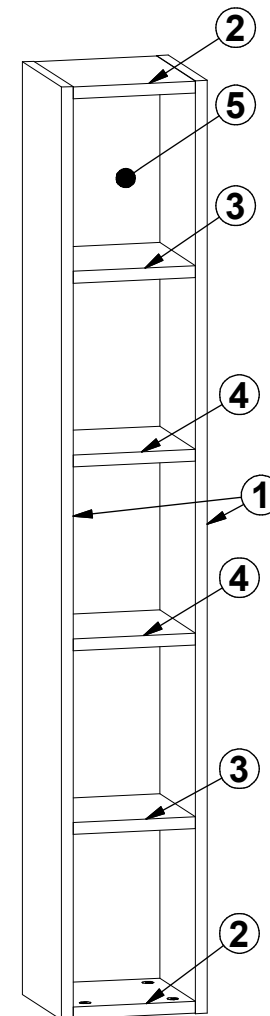
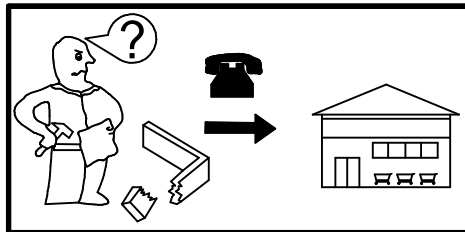
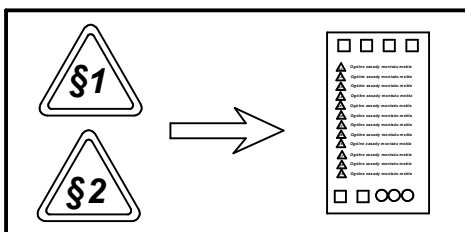
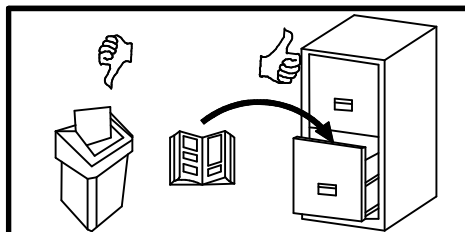
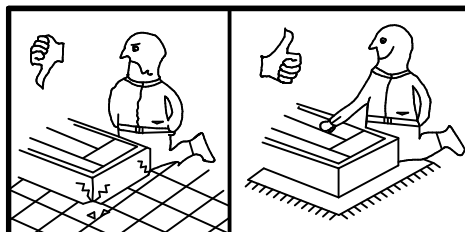
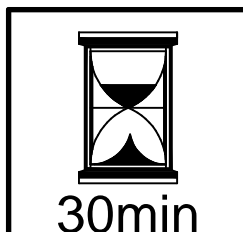
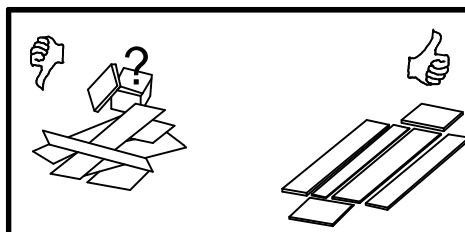
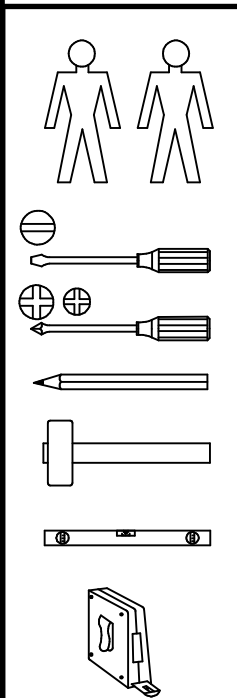
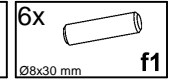
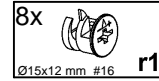
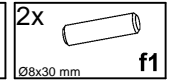
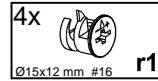
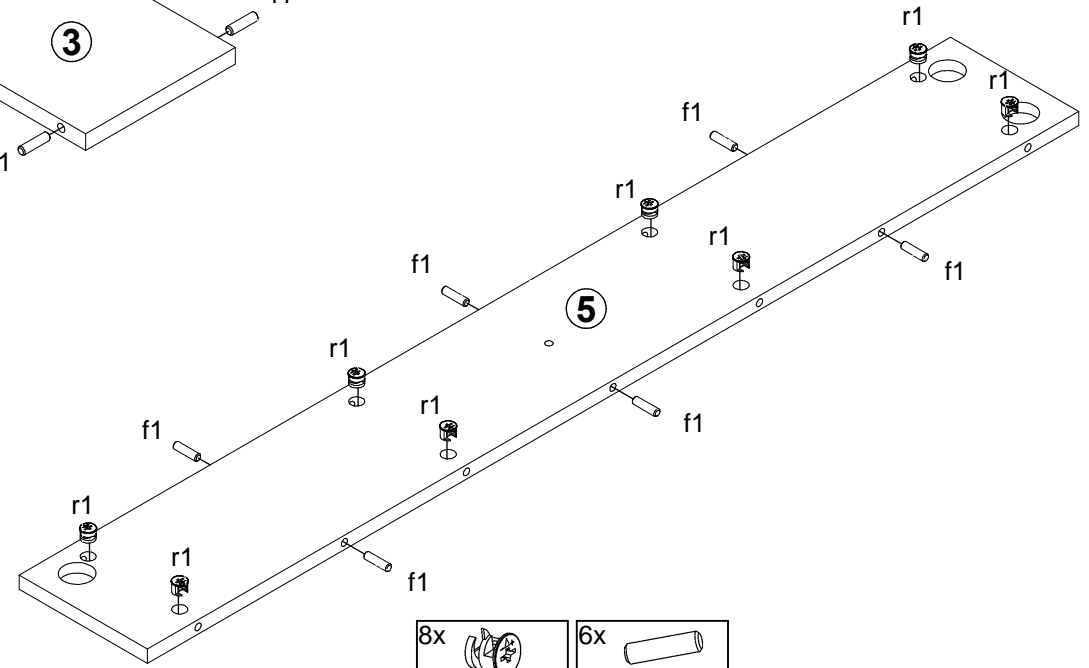
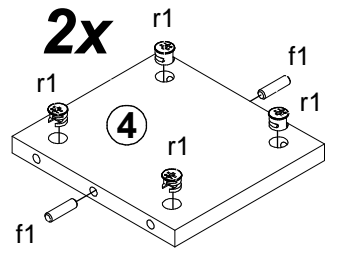
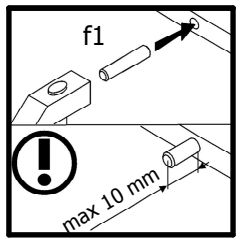
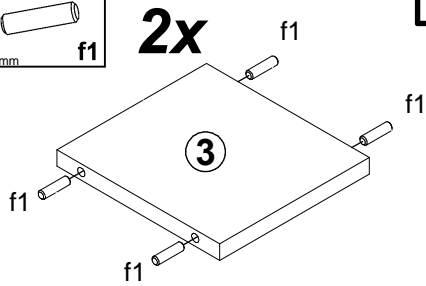
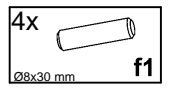
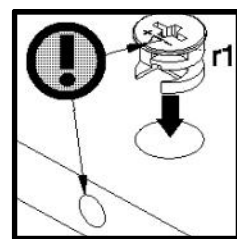
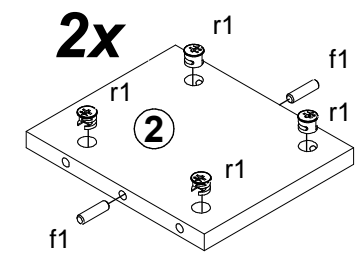
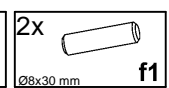
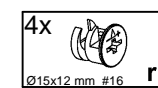
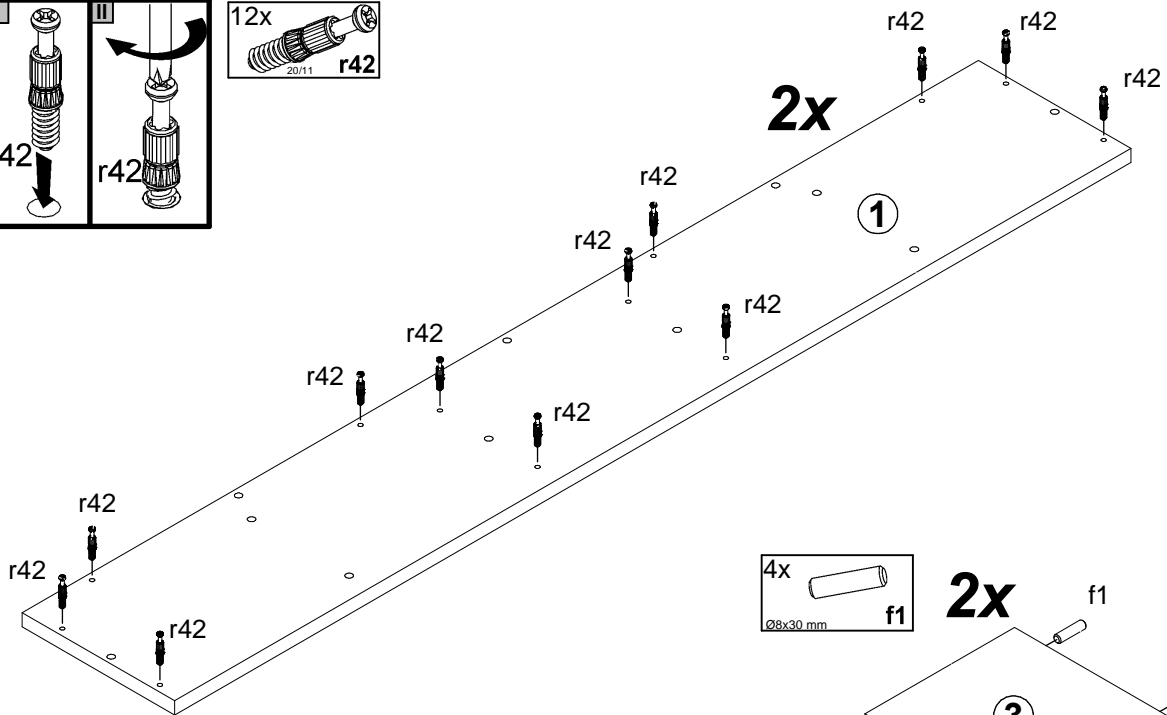
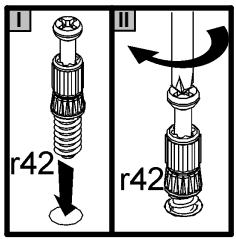

A

S507-SFW/13/2

10 H9 -- 15

3 / 6

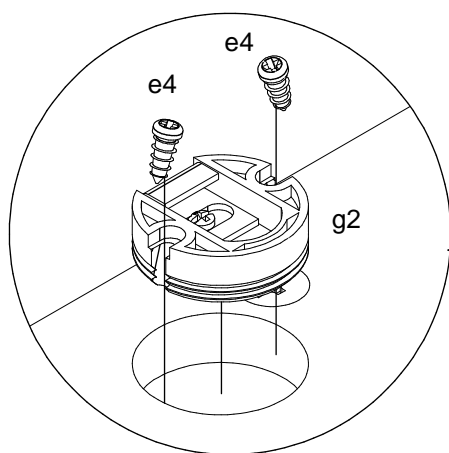

A

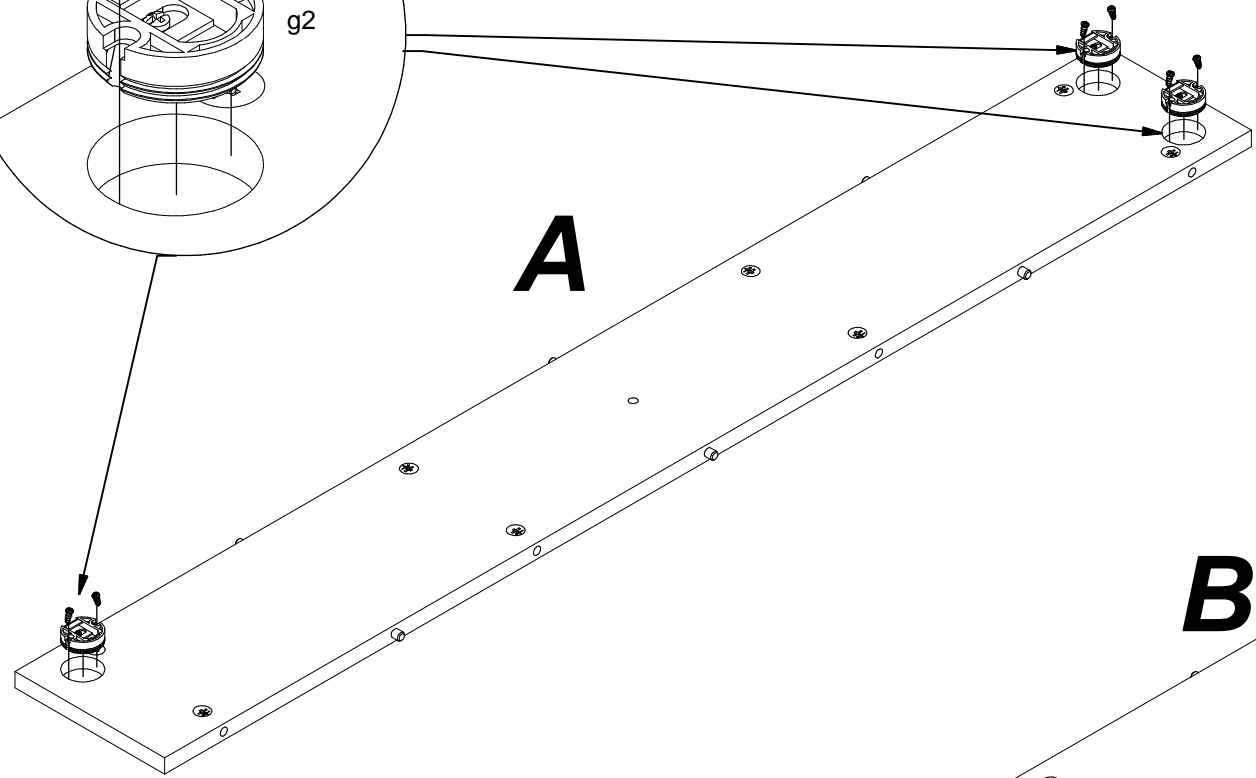

B

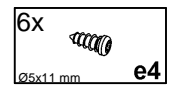
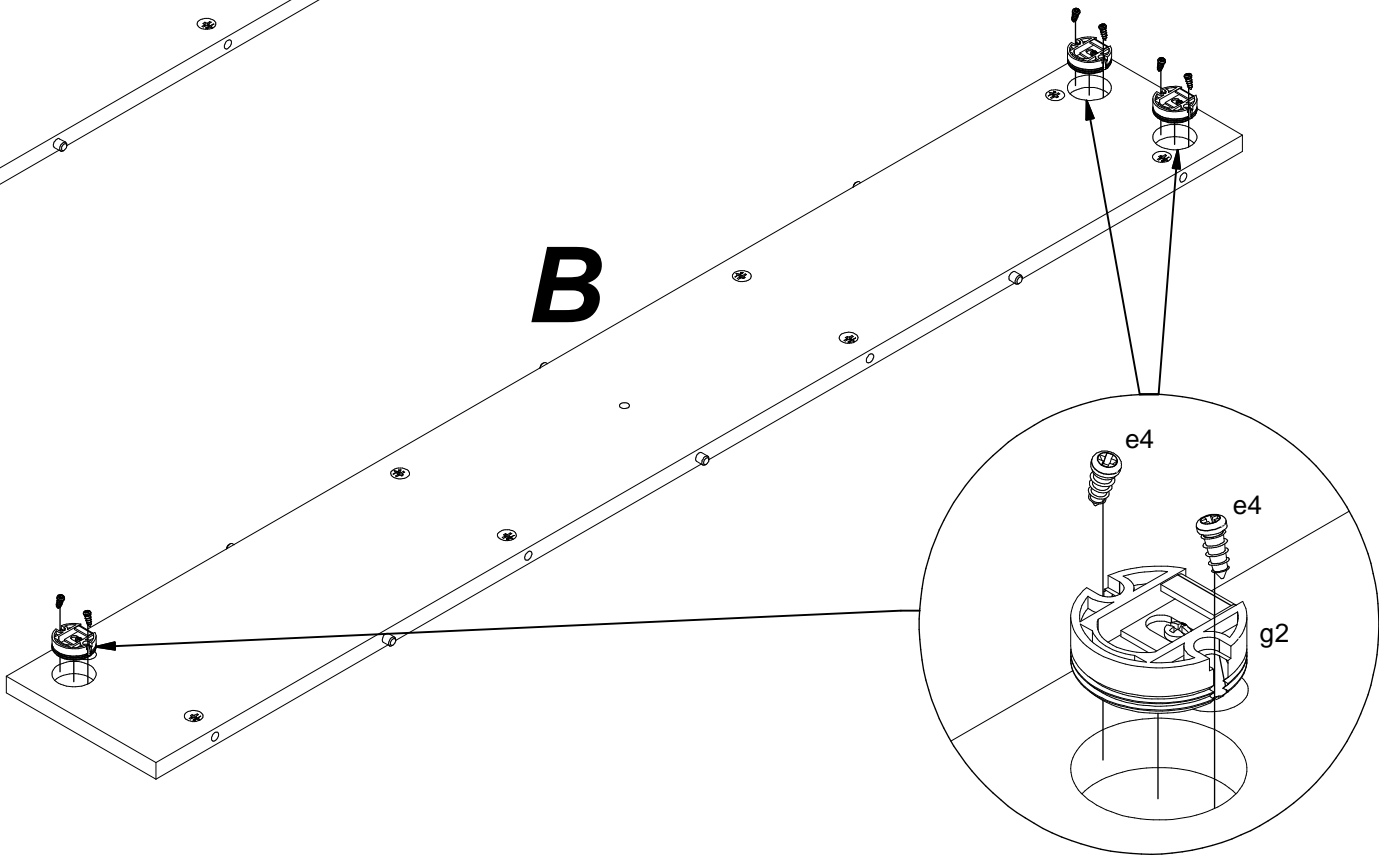

1

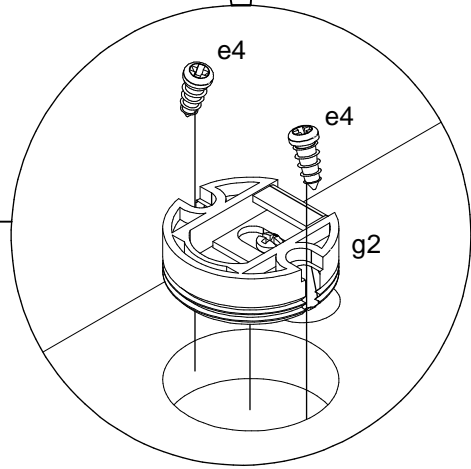
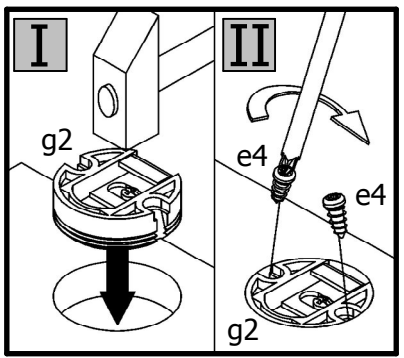

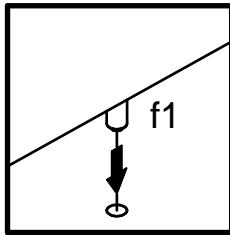
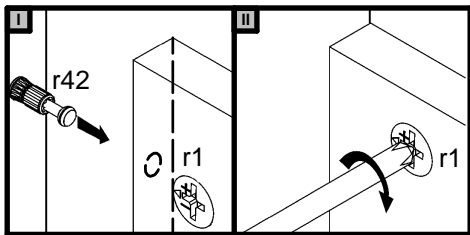

4

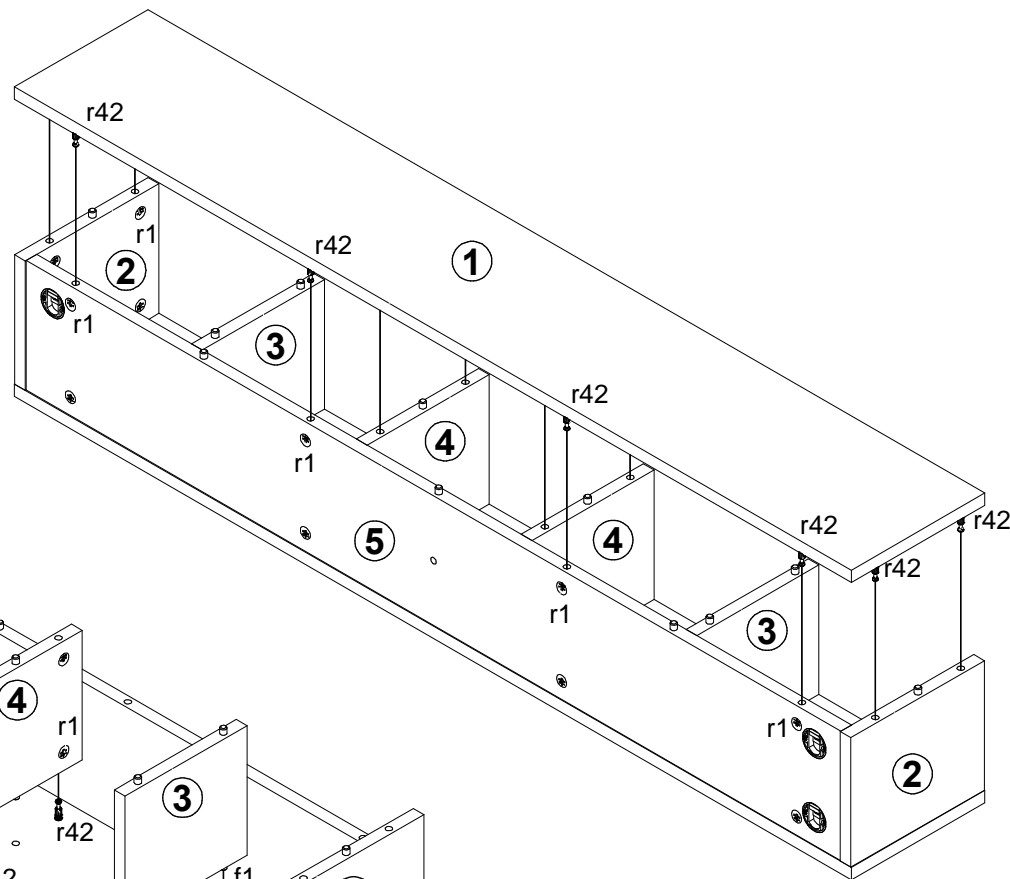

2

3

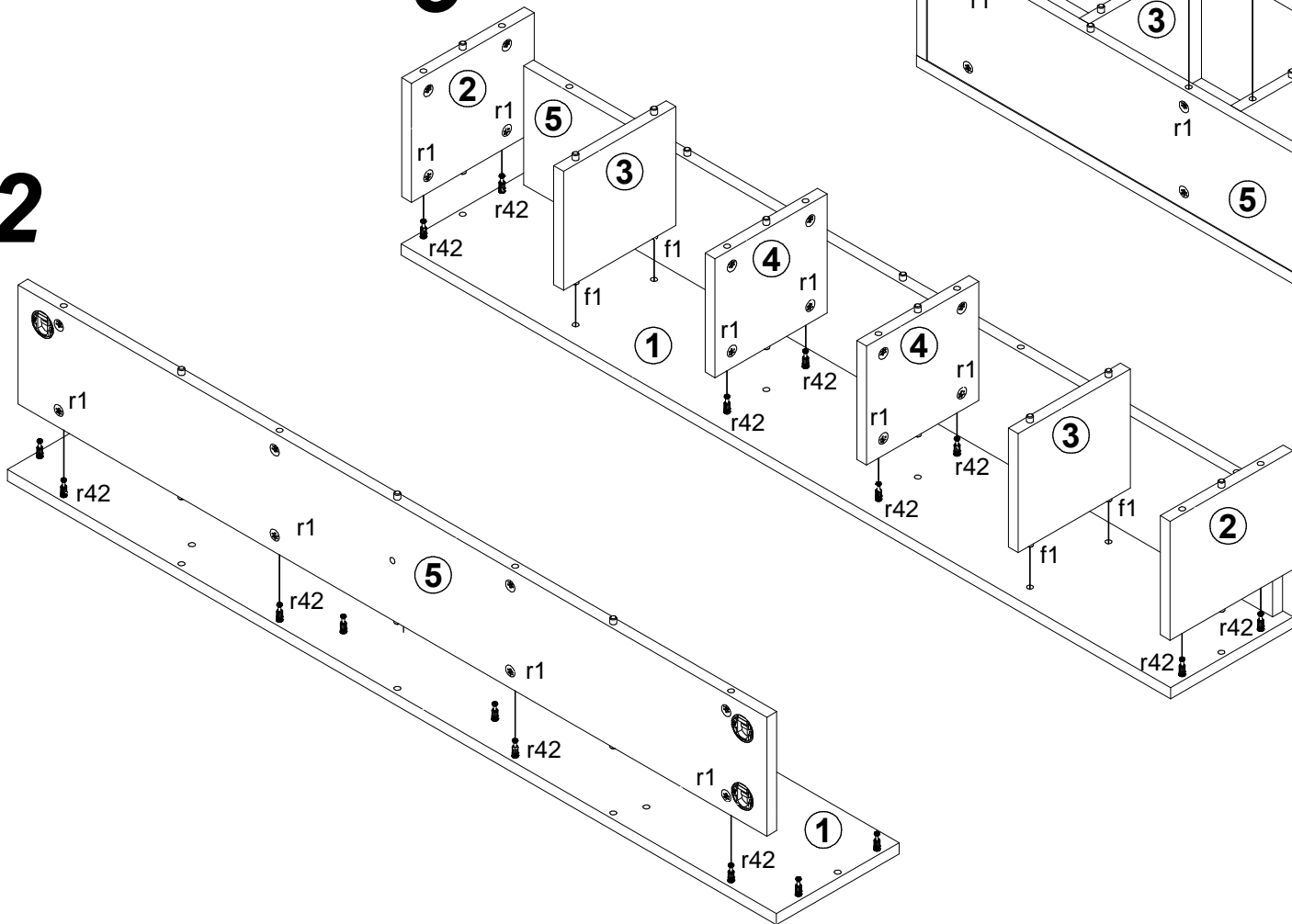

5

A

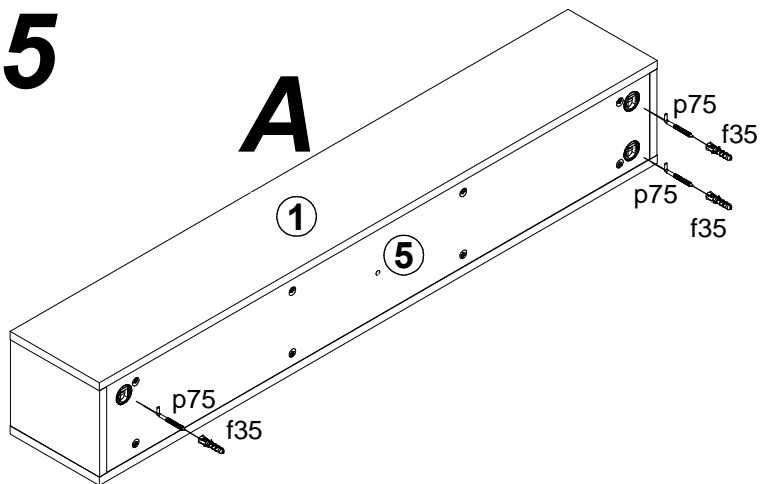

B

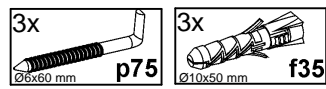
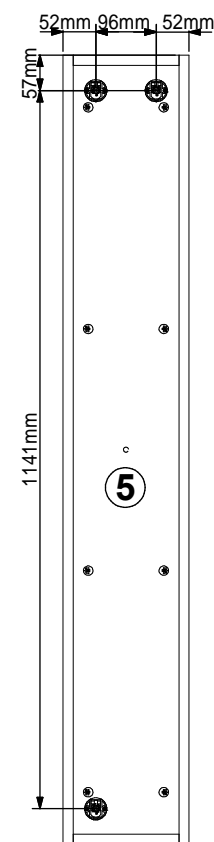
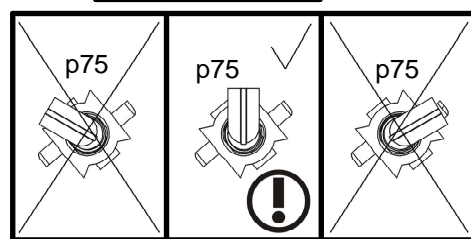
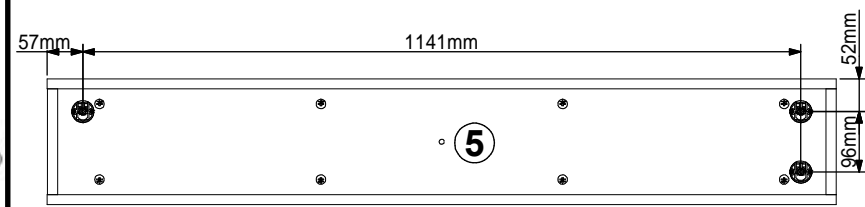
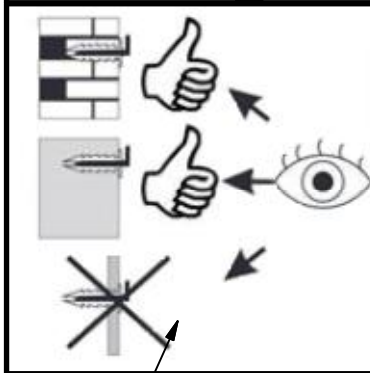
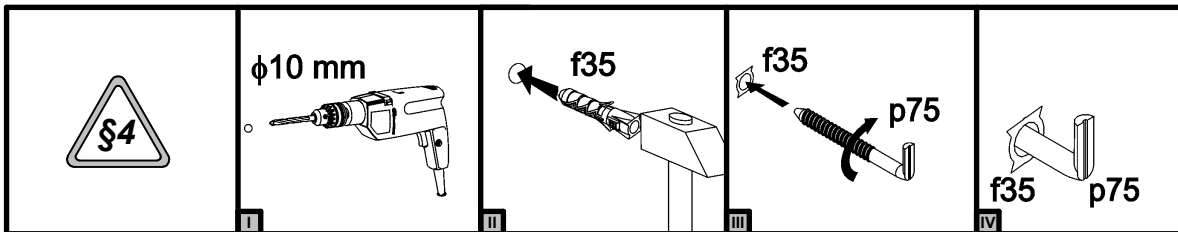
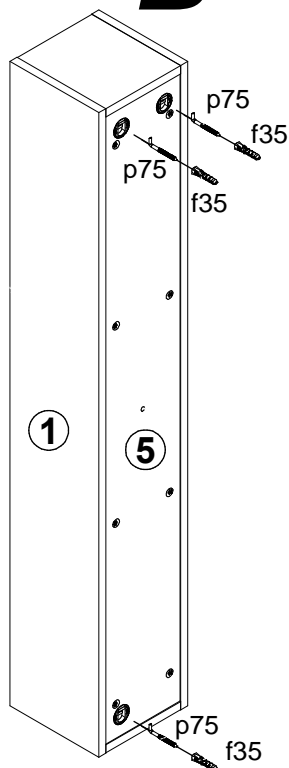

6

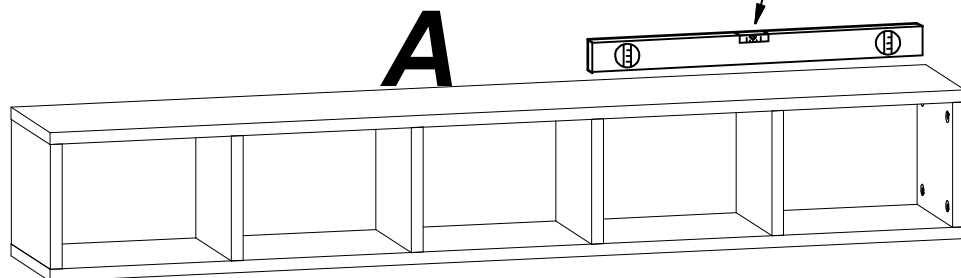
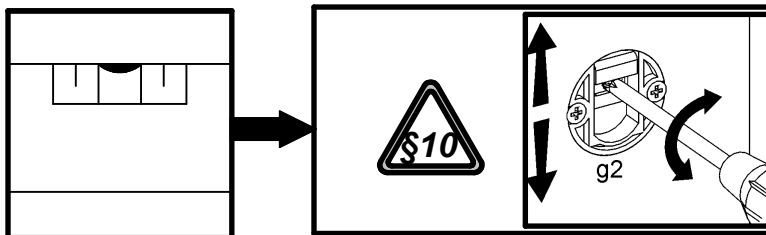

B

